

Installation Instructions for 26" Rectangle 3 Port Fast Jack LED Power Canopy

IMPORTANT INFORMATION

- This product is ETL listed for indoor dry locations.
- This product can be installed to a 4" electrical box with round plaster ring, or to an octagon electrical box.
- For dimming information visit www.edgelighting.com.
- This product can be used with LED or halogen Fast Jack fixtures.

SAVE THESE INSTRUCTIONS!



Install the Canopy

A

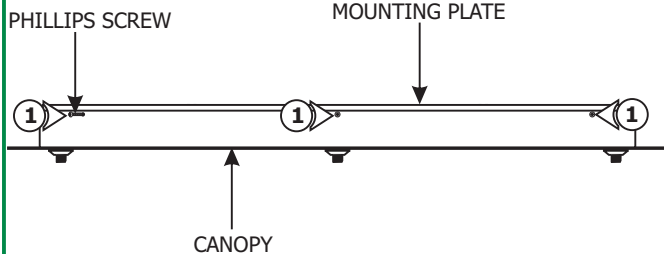

- 1:** Loosen and remove the six Phillips screws from the canopy to remove the mounting plate.

- 2:** Align the mounting plate holes with the electrical box holes and mark a point through the mounting plate holes onto the ceiling. These points are used for the anchors.

B

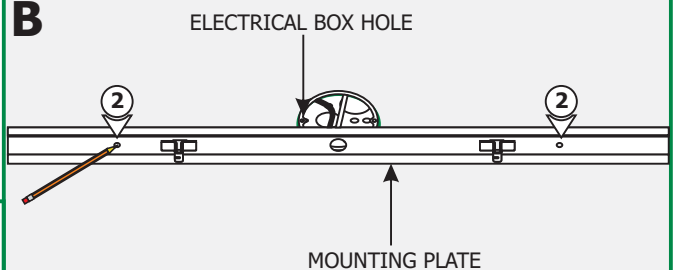

C

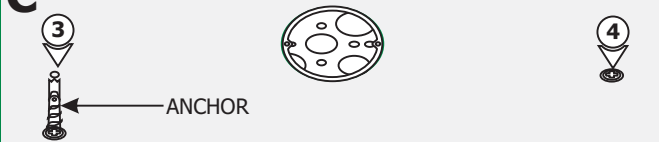

- 3:** Tap the anchors onto the marked points up to the threaded portion with a hammer.

- 4:** Screw in the threaded portion of the anchors with a Phillips screwdriver.

- 5:** Feed the power wires through the crossbar assembly center hole.

- 6:** Mount the crossbar assembly to the electrical box holes with the provided #8-32 screws.

D

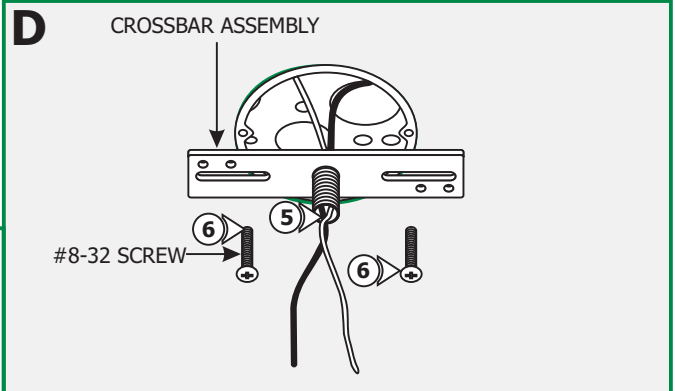

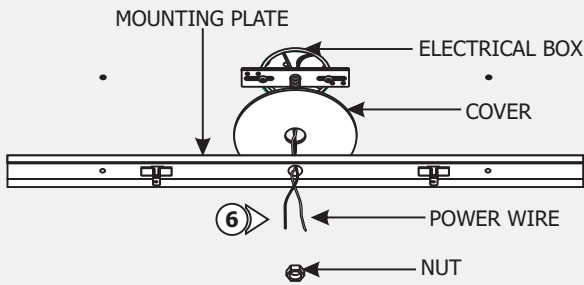
E

7: Slide the cover and mounting plate center hole onto the crossbar threaded nipple and secure it with the nut provided.

8: Secure the mounting plate to the anchors with the provided #8 screws.

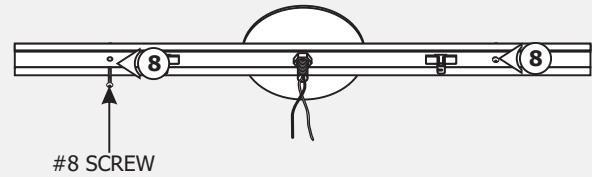
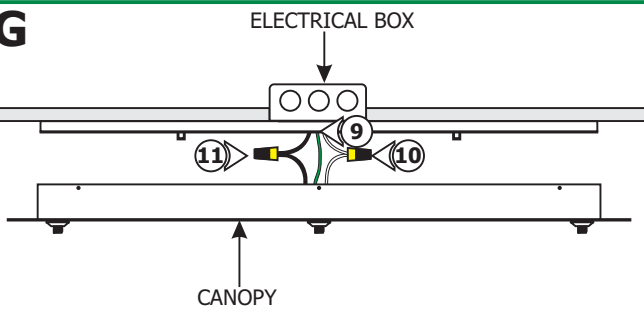
F**G**

9: Make sure the mounting plate is grounded in accordance with local electrical codes.

10: Connect the white fixture wire to the neutral power wire with a wire nut.

11: Connect the black fixture wire to the hot power wire with a wire nut.

12: Place all the wires and wire nut connections inside the canopy.

13: Align and secure the canopy to the mounting plate by tightening the six #8-32 screws.

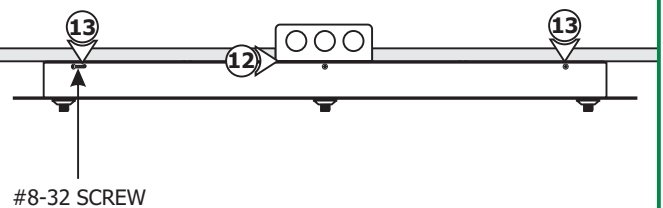
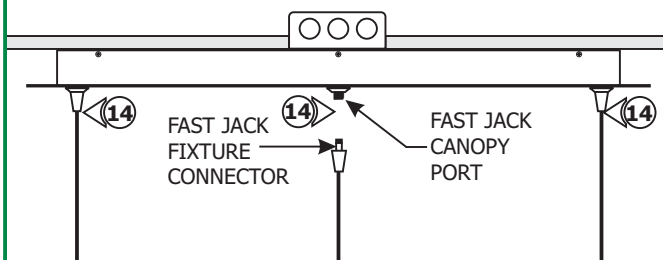
H**I**

CAUTION: Risk of Fire: MAX load of Fast Jack LED canopy is 60 watt per port.

14: Use fingers to tighten each Fast Jack fixture connector into one Fast Jack canopy port.