



Yolk
Chicago

SCOPE LED

Designed by
Gregory Kay
Patent Pending

PRODUCT INNOVATION
AWARD WINNER **PIA'11**

2011 AWARD



2010 AWARD



Adjust Beam by
turning **LED** Lens



FJ-SCLP-12-SN
Satin Nickel



FJ-SCLP-12-PN
Polished Nickel



FJ-SCLP-12-BZ
Antique Bronze



FJ-SCLP-12-PN-SCRY
Polished Nickel

Pendants

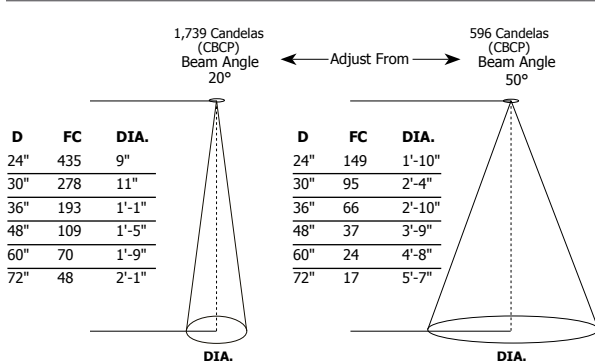

D - Distance from SCOPE LED fixture
FC - Initial footcandles at the center of beam
DIA - Diameter

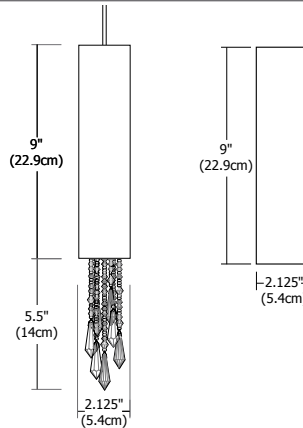

The Scope LED pendant, a classic contemporary cylinder pendant, features a **cool-to-the-touch** rotating lens to adjust the beam angle from 20° spot to 50° flood while the fixture is lit. It accommodates a crystal assortment accessory (SCRY – sold separately) to enrich the lighting design. It includes eight feet of field-cutable cable with fast jack connector. Design by Gregory Kay. Fixture includes 5 year warranty.

SYSTEM COMPATIBILITY Monorail (M), Monorail 2 Circuit (M2), use Fast Jack (FJ) version for FJ LED canopies (see pp. 91-93)

FINISH Satin Nickel, Polished Nickel or Antique Bronze

LAMP SPECIFICATION 12VAC LED, 70% lumen maintenance based on 50,000 hours of operation (see halogen comparison chart on pp. 206-207)

BEAM SPREAD	LUMENS	WATTS	LUMENS PER WATT	CBCP	COLOR TEMP (K)	CRI
20 degrees	217	9.3	23.3	1,739	2,994	83
50 degrees	315	9.3	33	596	2,994	83

ORDERING CODE: **FJ** - **SCLP** - **12** - **SN** - Standard (no crystal) leave blank

FJ Fast Jack
M Monorail
M2 Monorail 2 Circuit
SCLP Scope LED Pendant
12 12VAC
SN Satin Nickel
PN Polished Nickel
BZ Antique Bronze
SCRY Scope Pendant Crystal Accessory

ALPS

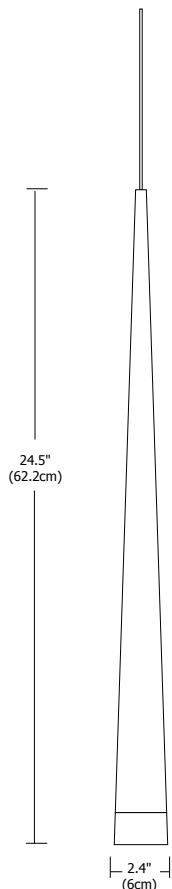

FJ-ALPS-BKWH-12-SN
Black and White

Alps pendant is a sleek black metal cone tipped with white glass at the bottom. Includes low-voltage, 35 watt halogen bi-pin lamp. Eight feet of field-cutttable coaxial cable with Fast Jack Connector also provided.

ICE

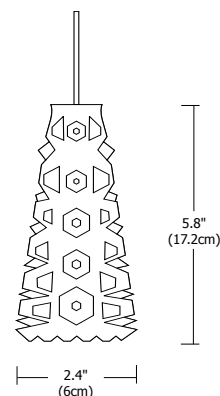

FJ-ICE-12-SN
Satin Nickel

Ice pendant features an elegant ice cube crystal glass shade. Includes a 35 watt MR11 lamp and provides a wide beam spread. Eight feet of field-cutttable coaxial cable with Fast Jack Connector also provided.

SYSTEM COMPATIBILITY	Monorail (M), Monorail 2 Circuit (M2), use Fast Jack (FJ) version for FJ canopies (see pp. 91-93)	SYSTEM COMPATIBILITY	Monorail (M), Monorail 2 Circuit (M2), use Fast Jack (FJ) version for FJ canopies (see pp. 91-93)
FINISH	Satin Nickel, Polished Nickel or Antique Bronze	FINISH	Satin Nickel, Polished Nickel or Antique Bronze
LAMP SPECIFICATION	Maximum 35 watt GY6.35 bi-pin (included) - 12 or 24 volt	LAMP SPECIFICATION	Maximum 35 watt MR11 lamp bi-pin (included) - 12 or 24 volt

ORDERING CODE: **FJ** - **ALPS** - **BKWH** - **12** - **SN**

FJ Fast Jack Monorail
M Monorail
M2 Monorail 2 Cir.

ALPS Alps
BKWH Black & White
12 12 Volt
24 24 Volt
SN Satin Nickel
PN Polished Nickel
BZ Antique Bronze

ORDERING CODE: **FJ** - **ICE** - **12** - **SN**

FJ Fast Jack Monorail
M Monorail
M2 Monorail 2 Circuit

ICE Ice
12 12 Volt
24 24 Volt
SN Satin Nickel
PN Polished Nickel
BZ Antique Bronze

EVEREST



FJ-EVE-CL-12-SN
Clear



FJ-EVE-PL-12-SN
Platinum

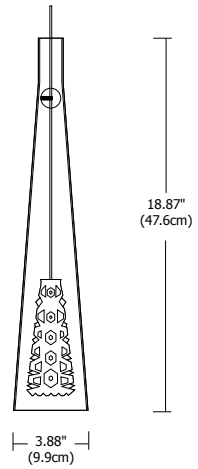

Pendants

Everest pendant features an elegant ice cube crystal glass floating inside clear or platinum outer glass. Includes a 35 watt IR MR11 lamp and provides a wide beam spread. Eight feet of field-cuttable coaxial cable with Fast Jack Connector also provided.

SYSTEM COMPATIBILITY Monorail (M), Monorail 2 Circuit (M2), use Fast Jack (FJ) version for FJ canopies (see pp. 91-93)

FINISH Satin Nickel, Polished Nickel or Antique Bronze

LAMP SPECIFICATION Maximum 35 watt MR11 lamp bi-pin (included) - 12 or 24 volt

ORDERING CODE	SYSTEM	SHADE	COLOR	VOLTAGE	FINISH
FJ	FJ Fast Jack	EVE Everest	CL Clear	12 12 Volt	SN Satin Nickel
M	M Monorail		PL Platinum	24 24 Volt	PN Polished Nickel
M2	M2 Monorail 2 Circuit				BZ Antique Bronze

TOWER OF CRYSTAL LOVE & TOWER OF LOVE "SATIN"

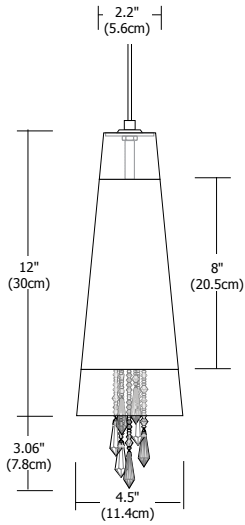

FJ-TOL-CS-12-SN-TCRY



FJ-TOL-CS-12-SN

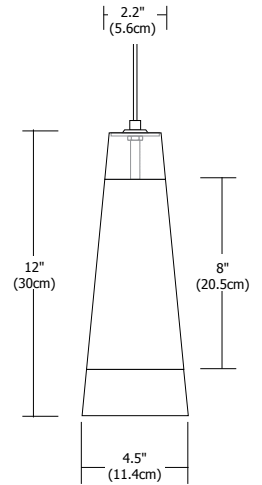

Tower of Crystal Love and the Tower of Love "Satin" feature a glass-frosted central shade flanked with clear edges. Crystals hang from inside the Tower of Crystal Love pendant. Includes 8 feet of field-cuttable coaxial cable and a 35 watt bi-pin lamp with Fast Jack connectors.

SYSTEM COMPATIBILITY Monorail (M), Monorail 2 Circuit (M2), use Fast Jack (FJ) version for FJ canopies (see pp. 91-93)

FINISH Satin Nickel, Polished Nickel or Antique Bronze

LAMP SPECIFICATION Maximum 35 watt IR GY6.35 bi-pin (included) - 12 or 24 volt

ORDERING CODE	SYSTEM	SHADE	COLOR	VOLTAGE	FINISH	TYPE
FJ	FJ	TOL	CS	12	SN	Standard (no crystal) leave blank
	Fast Jack Monorail	Tower of Love	Clear Satin Frost	12 12 Volt 24 24 Volt	Satin Nickel Polished Nickel Antique Bronze	Crystal Accessory for Tower of Love
	M2 Monorail 2 Circuit					

TOWER OF LOVE SHATTERED



FJ-TOL-SGB-12-SN
Shattered Golden Burgundy



FJ-TOL-SGA-12-SN
Shattered Golden Amber



FJ-TOL-SLA-12-SN
Shattered Lite Amber



FJ-TOL-SGW-12-SN
Shattered Golden White



FJ-TOL-SSC-12-SN
Shattered Silver Clear

Pendants

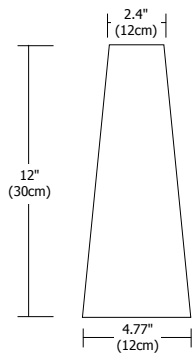

Tower of Love Shattered features a cone shade with an intricate crushed glass mosaic pattern. Shattered Golden Burgundy, Shattered Golden Amber, Shattered Lite Amber and Shattered Golden White shades glisten with an inner layer of gold leaf. The Shattered Silver Clear shade is accented with inner layer of silver leaf. Fixture includes low-voltage, 35 watt IR **halogen** bi-pin lamp (which offers 25% more energy savings and equal brightness when compared to a standard 50 watt bi-pin at 4,000 hour lamp life). Eight feet of field-cuttable coaxial cable included with Fast Jack Connector.

SYSTEM COMPATIBILITY	Monorail (M), Monorail 2 Circuit (M2), use Fast Jack (FJ) version for FJ canopies (see pp. 91-93)
FINISH	Satin Nickel, Polished Nickel or Antique Bronze
LAMP SPECIFICATION	Maximum 35 watt IR GY6.35 bi-pin (included) - 12 or 24 volt

ORDERING CODE	SYSTEM	SHADE	COLOR	VOLTAGE	FINISH
FJ M M2	FJ Fast Jack M Monorail M2 Monorail 2 Circuit	TOL Tower of Love	SGB Shattered Golden Burgundy SGA Shattered Golden Amber SLA Shattered Lite Amber SGW Shattered Golden White SSC Shattered Silver Clear	12 12 Volt 24 24 Volt	SN Satin Nickel PN Polished Nickel BZ Antique Bronze

WHITE NIGHT & DARK NIGHT



FJ-NIGHT-WH-12-SN

White Night



FJ-NIGHT-BK-12-SN

Dark Night

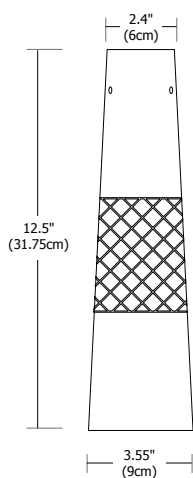

White Night and Dark Night are white and black conical shades, respectively, with crossed lines in the middle that allow light to shine through. Includes 8 feet of field-cutttable coaxial cable and Fast Jack Connector.

SYSTEM COMPATIBILITY Monorail (M), Monorail 2 Circuit (M2), use Fast Jack (FJ) version for FJ canopies (see pp. 91-93)

FINISH Satin Nickel, Polished Nickel or Antique Bronze

LAMP SPECIFICATION Maximum 35 Watt IR GY6.35 bi-pin (included) - 12 or 24 volt

ORDERING CODE	SYSTEM	SHADE/COLOR	VOLTAGE	FINISH
FJ	NIGHT-WH	12	SN	
FJ Fast Jack	NIGHT-WH White Night	12 12 Volt	SN Satin Nickel	
M Monorail	NIGHT-BK Dark Night	24 24 Volt	PN Polished Nickel	
M2 Monorail 2 Circuit			BZ Antique Bronze	

CROSSROADS



FJ-CRR-SL-12-SN



FJ-CRR-BK-12-SN



FJ-CRR-GL-12-SN

KINGS CROSSING



FJ-KC-SL-12-SN



FJ-KC-BK-12-SN



FJ-KC-GL-12-SN

Pendants

Crossroads and Kings Crossing feature color cone glass with double groove lines allowing light to shine through. Kings Crossing also features a set of crystals hanging from the center. Includes 8 feet of field-cuttable coaxial cable and Fast Jack Connector.

SYSTEM COMPATIBILITY Monorail (M), Monorail 2 Circuit (M2), use Fast Jack (FJ) version for FJ canopies (see pp. 91-93)

FINISH Satin Nickel, Polished Nickel or Antique Bronze

LAMP SPECIFICATION Maximum 50 watt GY6.35 bi-pin lamp (included) - 12 or 24 volt

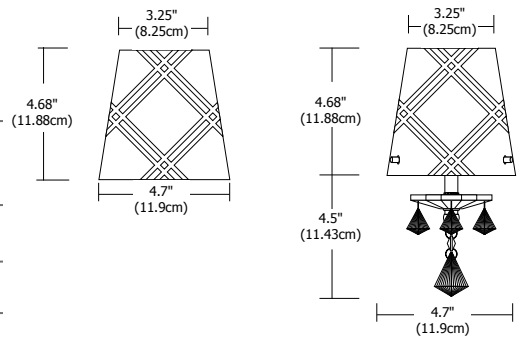

ORDERING CODE	SYSTEM	SHADE	COLOR	VOLTAGE	FINISH
FJ	M	CRR	SL	12	SN
M2	M2	KC	GL	24	PN
			BK		BZ

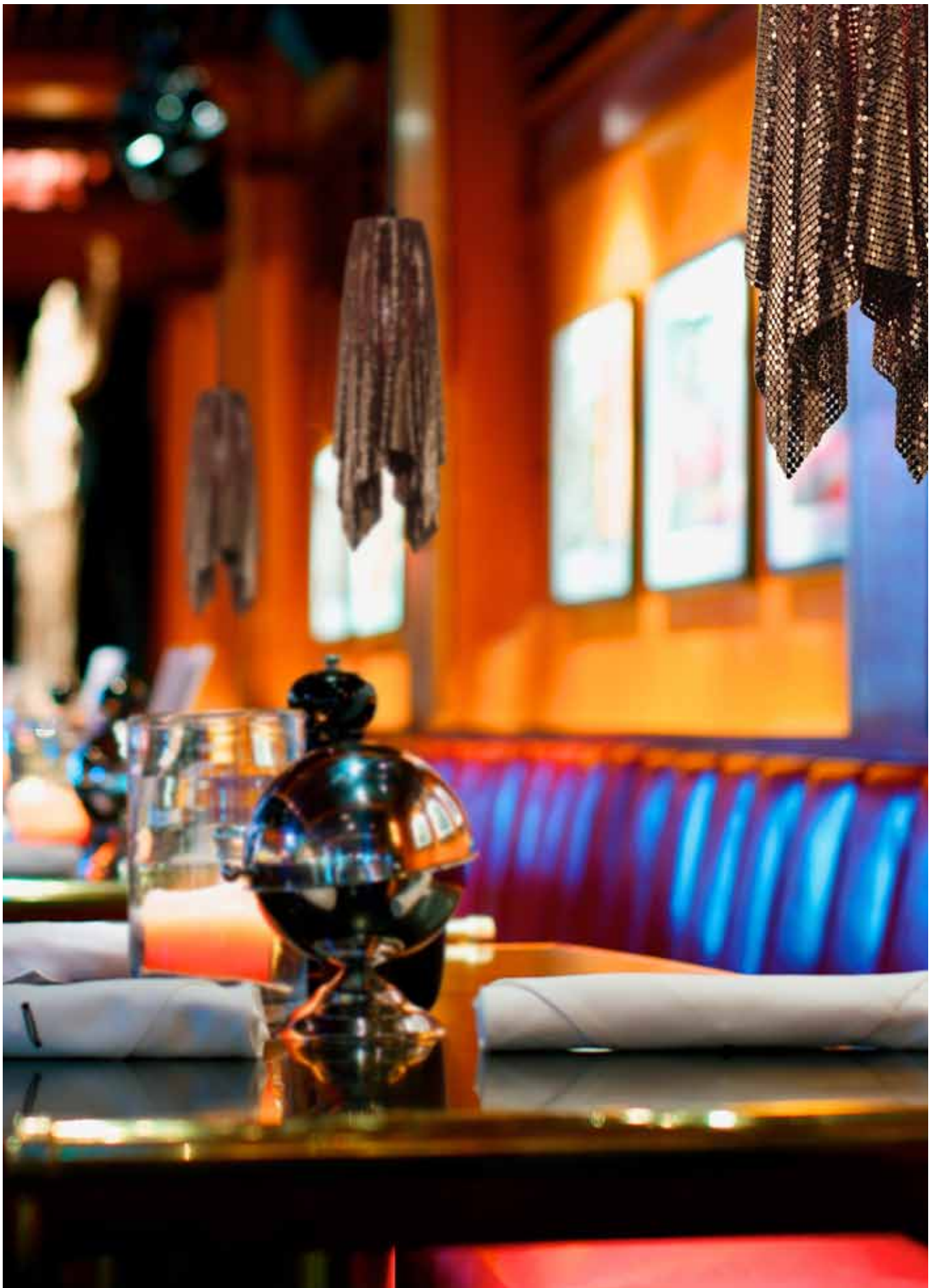

MATA HARI



Pendants

FJ-MATA3-BR-12-BZ
Brass

FJ-MATA3-CO-12-BZ
Copper

FJ-MATA3-BK-12-SN
Black

FJ-MATA3-PL-12-SN
Platinum

FJ-MATA3-SL-12-SN
Silver

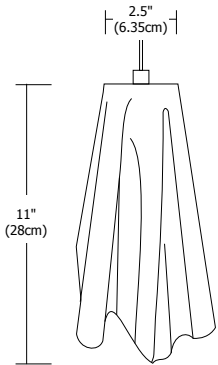

Mata Hari glistens through the metal cloth shade, enhancing fixture color while projecting the woven pattern in the surrounding space. Includes eight feet of field-cuttable coaxial cable and Fast Jack connector.

SYSTEM COMPATIBILITY Monorail (M), Monorail 2 Circuit (M2), use Fast Jack (FJ) version for FJ canopies (see pp. 91-93)

FINISH Satin Nickel, Polished Nickel or Antique Bronze

LAMP SPECIFICATION Maximum 50 watt MR16 GU5.3 base (not included) - 12 or 24 volt

ORDERING CODE	SYSTEM	SHADE	COLOR	VOLTAGE	FINISH
FJ	FJ	MATA3	SL	12	SN
<small>FJ</small>	<small>M</small> Fast Jack <small>M2</small> Monorail 2 Circuit	<small>MATA3</small> Mata Hari 3	<small>BK</small> Black <small>BR</small> Brass <small>SL</small> Silver <small>CO</small> Copper <small>PL</small> Platinum	<small>12</small> 12 Volt <small>24</small> 24 Volt	<small>SN</small> Satin Nickel <small>PN</small> Polished Nickel <small>BZ</small> Antique Bronze

OUTLAW



FJ-OL-10FT-12-SN
Satin Nickel

The Outlaw Lamp Pendant is a blown white glass shaped like an incandescent "A" lamp with 20 watt bi-pin halogen lamp inside. Available with Fast Jack connector and 10, 20 or 30 ft long field-cutttable coaxial cable that may be cut in at the job site.

Zzz LAMP



FJ-ZL-20FT-12-SN
Satin Nickel

The Zzz Lamp Pendant, are a blown white glass shaped like an "A" lamp on its side with 20 watt bi-pin halogen lamp inside. Available with Fast Jack connector and 10, 20 or 30 ft long field-cutttable coaxial cable that may be cut in at the job site.

SYSTEM COMPATIBILITY	Monorail (M), Monorail 2 Circuit (M2), use Fast Jack (FJ) version for FJ canopies (see pp. 91-93)	SYSTEM COMPATIBILITY	Monorail (M), Monorail 2 Circuit (M2), use Fast Jack (FJ) version for FJ canopies (see pp. 91-93)
FINISH	Satin Nickel or Polished Nickel	FINISH	Satin Nickel or Polished Nickel
LAMP SPECIFICATION	Maximum 20 watt G4 bi-pin (included) - 12 or 24 volt	LAMP SPECIFICATION	Maximum 20 watt G4 bi-pin (included) - 12 or 24 volt

ORDERING CODE	SYSTEM	SHADE	CABLE/CORD	VOLTAGE	FINISH
FJ	FJ Fast Jack M Monorail M2 Monorail 2 Circuit	OL Outlaw	10FT 10 ft. 20FT 20 ft. 30FT 30 ft.	12 12 Volt 24 24 Volt	SN Satin Nickel PN Polished Nickel

ORDERING CODE	SYSTEM	SHADE	CABLE/CORD	VOLTAGE	FINISH
FJ	FJ Fast Jack M Monorail M2 Monorail 2 Circuit	ZL Zzz Lamp	10FT 10 ft. 20FT 20 ft. 30FT 30 ft.	12 12 Volt 24 24 Volt	SN Satin Nickel PN Polished Nickel

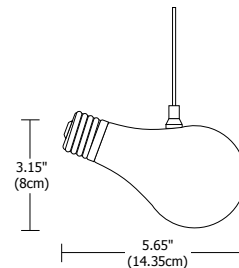
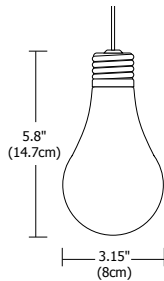

BLOOM



FJ-BLO-10FT-12-SN
Satin Nickel

Bloom pendant features a twisted globe shade with a crystal. It includes 10, 20 or 30 feet of field-cutttable coaxial cable with 20 watt bi-pin lamp and Fast Jack connector.

DROP



FJ-DROP-12-SN
Satin Nickel

Drop pendant features an organically shaped clear blown glass shade effortlessly surrounding a 20 watt MR11 lamp and housing. The low voltage fixture allows for 1" of water to be added to the glass. Eight feet of field-cutttable cable and Fast Jack Connector provided.

<p>SYSTEM COMPATIBILITY Monorail (M), Monorail 2 Circuit (M2), use Fast Jack (FJ) version for FJ canopies (see pp. 91-93)</p>	<p>SYSTEM COMPATIBILITY Monorail (M), Monorail 2 Circuit (M2), use Fast Jack (FJ) version for FJ canopies (see pp. 91-93)</p>
<p>FINISH Satin Nickel or Polished Nickel</p>	<p>FINISH Satin Nickel</p>
<p>LAMP SPECIFICATION Maximum 20 watt G4 bi-pin (included) - 12 or 24 volt</p>	<p>LAMP SPECIFICATION Maximum 20 watt MR11 GU4 Halogen (included) - 12 or 24 volt</p>

ORDERING CODE	SYSTEM	SHADE	CABLE/CORD	VOLTAGE	FINISH
FJ	FJ Fast Jack M Monorail M2 Monorail 2 Circuit	BLO Bloom	10FT 10 ft. 20FT 20 ft. 30FT 30 ft.	12 12 Volt 24 24 Volt	SN Satin Nickel PN Polished Nickel

ORDERING CODE	SYSTEM	DROP	VOLTAGE	FINISH
FJ	FJ Fast Jack M Monorail M2 Monorail 2 Circuit	DROP Drop	12 12 Volt 24 24 Volt	SN Satin Nickel

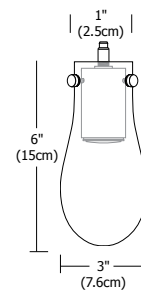
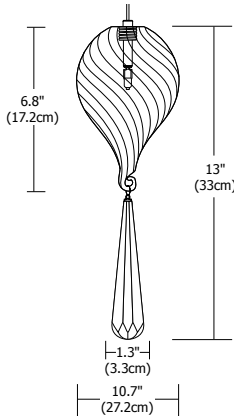

BUBBLE BALL



FJ-BBBL-10FT-12-SN

Clear



FJ-BBAM-10FT-12-BZ

Amber



FJ-BBCL-10FT-12-SN

Clear



FJ-BBRD-10FT-12-SN

Red

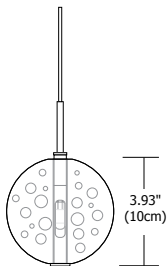

Bubble Ball is constructed of crystal glass with a scattered bubble pattern. Field-cutable (10, 20 or 30 ft) coaxial cable and FJ-MCH (fast jack male connector heavy-duty) provided.

SYSTEM COMPATIBILITY Monorail (M), Monorail 2 Circuit (M2), use Fast Jack (FJ) version for FJ canopies (see pp. 91-93)

FINISH Satin Nickel, Polished Nickel, or Antique Bronze

LAMP SPECIFICATION Maximum 20 watt G4 bi-pin Halogen (included) - 12 or 24 volt

ORDERING CODE	SYSTEM	SHADE	CABLE/CORD	VOLTAGE	FINISH
FJ	FJ	BBCL	10FT	12	SN
M	M Fast Jack	BBBL Bubble Ball Clear	10FT 10 ft.	12 12 Volt	SN Satin Nickel
M2	M2 Monorail	BBBL Bubble Ball Blue	20FT 20 ft.	24 24 Volt	PN Polished Nickel
		BBAM Bubble Ball Amber	30FT 30 ft.		BZ Antique Bronze
		BBRD Bubble Ball Red			

CRYSTAL SPIRIT 10"

Pendants



FJ-CRISP10-CL-WH-12-SN

Satin Nickel

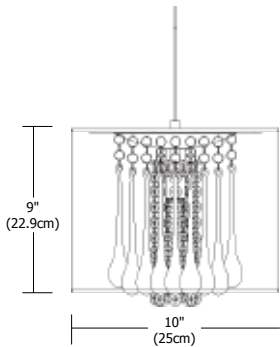

Crystal Spirit suspension features white silk shade with clear crystal accents that provide general light distribution. Eight feet of field-cuttable coaxial cable and FJ-MCH (fast jack male connector heavy-duty) provided.

SYSTEM COMPATIBILITY Monorail (M), Monorail 2 Circuit (M2), use Fast Jack (FJ) version for FJ canopies (see pp. 91-93)

FINISH Satin Nickel

LAMP SPECIFICATION Maximum 50 watt GY6.35 bi-pin Xenon (included) - 12 or 24 volt

ORDERING CODE	SYSTEM	SHAPE	CRYSTAL COLOR	SHADE COLOR	VOLTAGE	FINISH
FJ	FJ	CRISP10	CL	WH	12	SN
	FJ Fast Jack M Monorail M2 Monorail 2 Circuit	CRYSP10 Crystal Spirit 10"	CL Clear	WH White	12 12 Volt 24 24 Volt	SN Satin Nickel